

# MechaTronix in LED

## LSB70 LED Star Heat Sink $\phi$ 70mm



### Features & Benefits

- Designed for high-performance convection cooling of power LEDs, COB modules and LED engines
- Thermal resistance Rth 2.53 - 5.0°C/W  
Cooling performance up to 20W (see thermal details)
- Diameter 70 mm base
- Standard height 50 mm & 80 mm  
Other heights on request
- Standard base thickness 10 mm  
Other base thicknesses on request  
Easy base plate customisation with mounting holes, cable guidance, reflector mounting options,...
- Extruded from highly conductive aluminium for optimal thermal performance  
Base plate design for advanced heat conduction and lower spreading resistance
- Standard colors clear anodised - black anodised

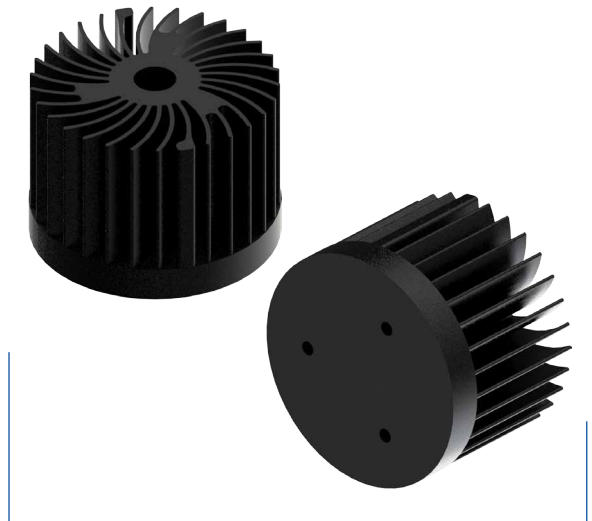

### Order Information

#### Thermal Interface Material

Please make sure to apply a high thermal conductive material between the heat sink base and the LED engine with an applied thickness between 0.1mm and 0.2mm

Advised materials:

- Thermally Conductive Grease  
High performance, more difficult to apply and control the thickness  
Example Laird Technologies Tgrease 880
- Thermal Gap Filler Pad with electrical insulation  
Medium to high performance, easy to apply  
Example Laird Technologies Tgard 500-A1
- Phase Change Thermal Interface Material  
This material applies like a thermal pad but becomes fluid and creates a perfect wetting at the first heating cycle  
Extra high performance, easy to apply  
Example Laird Technologies TPCM 585

Not using a suitable thermal conductive material will lead to either an insufficient wetting area or a high thermal resistance between LED engine and heat sink base both immediately resulting in an extra temperature increase of the LED junction

We do not advise the use of double sided thermal tapes without using extra mounting screws to create pressure

Thermal gap filler pads and phase change pads can be pre-applied by MechaTronix with specific cutting designs

Example: LSB7050-B

LSB70 1 - 2 - 3

- 1 Height (mm)
- 2 Anodising Color  
B - Black  
C - Clear
- 3 Mounting options  
On request:  
mounting holes, cable holes,  
screw thread, thermal interface pad

# MechaTronix in LED

## LSB70 LED Star Heat Sink $\phi$ 70mm



### Product Details

Model n°	LSB7050	LSB7080
Dimension (mm) <sup>*1</sup>	$\phi$ 70 x h50	$\phi$ 70 x h80
Volume (mm <sup>3</sup> )	94778.21	137110.53
Cooling Surface (mm <sup>2</sup> )	65844.13	107596.58
Weight (gr)	254.19	406.56
Thermal Resistance (°C/W) <sup>*2</sup>	5.0	2.53
Power Pd (W) <sup>*3</sup>	10	20
Heat Sink Material	AL6063-T5	AL6063-T5

\*1 3D files are available in ParaSolid, STP and IGS on request

\*2 The thermal resistance Rth is determined with a calibrated heat source of 30mm x 30mm central placed on the heat sink, Tamb 40° and an open environment.

Reference data @ heat sink to ambient temperature rise Ths-amb 50°C

The thermal resistance of a LED cooler is not a fix value and will vary with the applied dissipated power Pd

\*3 Dissipated power Pd. Reference data @ heat sink to ambient temperature rise Ths-amb 50°C

The maximal dissipated power needs to be verified in function of required case temperature Tc or junction temperature Tj and related to the estimated ambient temperature where the light fixture will be placed

Please be aware the dissipated power Pd is not the same as the electrical power Pe of a LED module

To calculate the dissipated power please use the following formula:  $Pd = Pe \times (1 - \eta_L)$

Pd - Dissipated power

Pe - Electrical power

$\eta_L$  = Light efficiency of the LED module

### Notes:

- MechaTronix reserves the right to change products or specifications without prior notice.
- Mentioned models are an extraction of full product range.
- For specific mechanical adaptations please contact MechaTronix.

# MechaTronix in LED

## LSB70 LED Star Heat Sink $\phi$ 70mm



### Drawings & Dimensions

Example: LSB7050

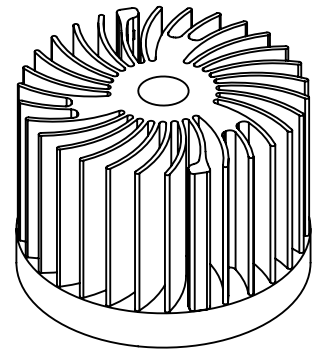
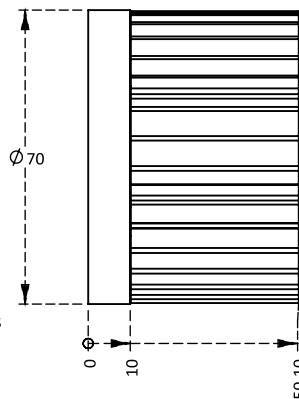
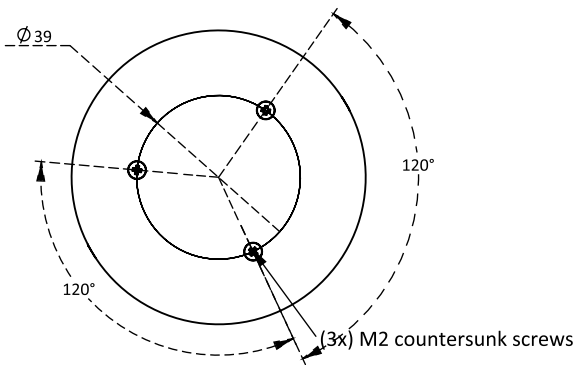

### Mounting Option Examples

The major advantage of these LED star heat sinks with additional base plate is the easy adaptation of the base plate to specific mounting patterns for various LED engines and optics

With some easy CNC afterwork we can go from simple mounting holes all the way up to a full customised LED cooler where the heat sink becomes part of the lighting fixture

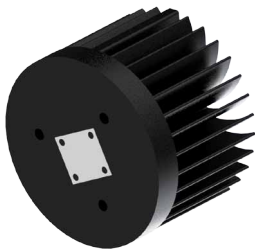

Thermal interface

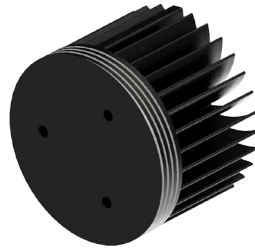

Outer screw thread

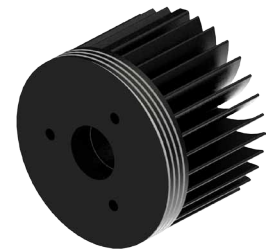

Cable hole + Outer screw thread

### Examples of customised LED star heat sinks:



# MechaTronix in LED

## LSB70 LED Star Heat Sink $\phi$ 70mm



### Thermal Data

$P_d = P_e \times (1-\eta_L)$			LED Light efficiency, $\eta_L$ (%)			Heat sink to ambient thermal resistance $R_{hs-amb}$ ( $^{\circ}C/W$ )		Heat sink to ambient temperature rise $T_{hs-amb}$ ( $^{\circ}C$ )	
			17%	20%	25%	LSB7050	LSB7080	LSB7050	LSB7080
Dissipated Power $P_d$ (W)	5	Electrical Power $P_e$ (W)	6.02	6.25	6.66	5.6	3.4	28	17
	7		8.43	8.75	9.33	5.3	3.2	37	22
	10		12.04	12.5	13.33	5.0	2.9	50	29
	15		18.07	18.75	20	-	2.7	-	40
	20		24.09	25	26.66	-	2.5	-	50
	25		30.12	31.25	33.33	-	2.4	-	60
	30		36.14	37.5	40	-	2.3	-	69

Heat sink to ambient temperature rise  $T_{hs-amb}$  ( $^{\circ}C$ )

— LSB7050 — LSB7080

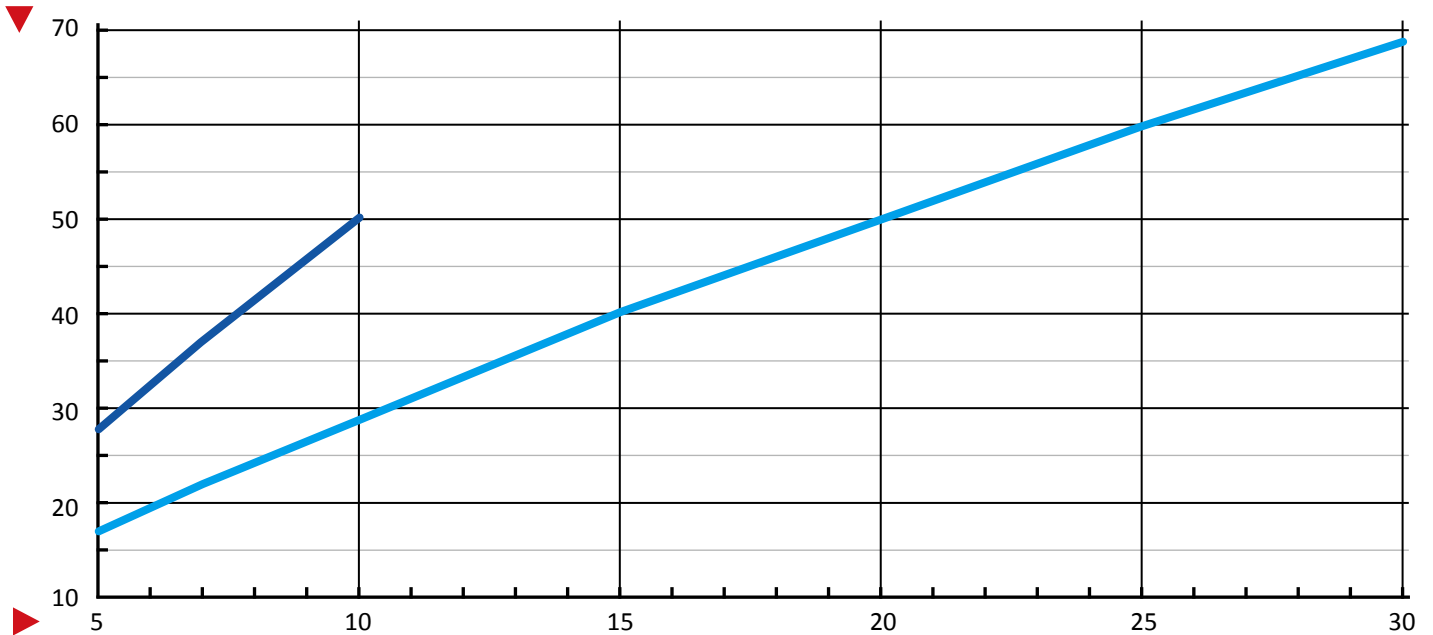

Dissipated Power  $P_d$ (W)